

PO Box 1317, Lisle, Il. 60532
Ph: (312) 961-3529

**MULTI - FUNCTION USER GROUP
MONTHLY NEWSLETTER - PUBLIC DOMAIN LIBRARY
DISCOUNT BUYING SERVICE FOR HDW & SFTW**

Issue #51 March, 1989
Editor: Lyle Marschand
Copyright @ 1988

Single Copy: \$3.00
Annual: (U.S. 3rd class) \$19.00
(U.S. 1st Class/Canada) \$26.00

Happy Easter

The enigma of the cross asks one basic question - **why did Jesus have to suffer so and die such a horrible death and then three days later rise from the dead in such glory ?**

These seem such opposites - the agony of the cross and the glory of the resurrection. I find that the Old Testament offers many facts that can lead to a better understanding of the New Testament truths.

Do you remember the story of the "Passover" ? This is when the Israelites were slaves in Egypt and *Moses was demanding that the Pharaoh let them go* so they could travel to the Promised Land as God had directed them.

God instructed Moses that he should tell Pharaoh that if he did not agree to letting the Israelites go, that all the first born males in Egypt would die the next night. Pharaoh rejected this ultimatum, even after God had done many other miracles to prove his power.

To protect the Israelite children, God instructed them to slay a Lamb and wipe its blood on the door post. This blood would be the sign that would cause the death angel to "passover" their homes. (Exodus 12:1-14)

The blood of the slain "innocent" lamb saved them from death. Their was no other way to escape this death and the Egyptians endured a horrible lesson because they did not heed God's words.

Throughout history, blood has been a symbol of salvation. The blood of the lamb saved the physical lives of the Israelite children just like the shed blood of Jesus on the cross has the power to save all of mankind from a spiritual death. Jesus' blood had to be shed to pay the price for our sins and to give us our "blood on the door post" so we will be "passed

over" when judgement comes.

God demands a perfect sacrifice for the shedding of blood and the forgiveness of sins. Jesus was the perfect, sinless man and the only one whose blood could provide salvation for all mankind.

The key here is that **Jesus' blood is the only way man can be saved**, just as the lambs blood on the door post was the only way the Israelites could be saved or "passed over" by death, so Jesus' blood is our only way to salvation.

Once a person accepts Jesus has their personal Lord and Saviour, the blood He shed on the cross can be used as the means of salvation for them. However, Jesus' death on the cross tells us that there is no other means to salvation and eternal life.

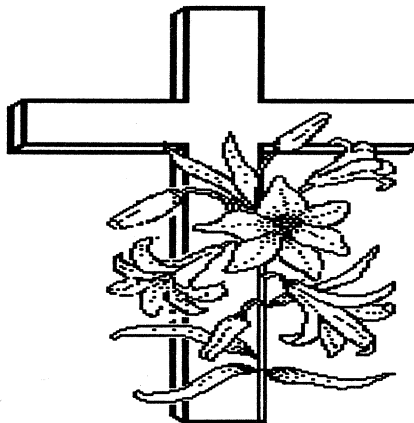

I used to think that if I was a "good person" all my life, then it would be fair for God to reward me with a trip to Heaven rather than Hell.

Not so !

If my personal idea of what was required for salvation was true, it would leave out millions of people who for what ever reason had made a one mistake and couldn't be classified as good enough for the Heaven trip. Thank God that He is smarter than me in devising a plan that is fair to all mankind!!

God's plan offers **forgiveness for past sins** as well as a way that does not require us to "do" certain things to earn salvation.

God's perfect plan was to provide a sacrifice whose blood could pay for all of the sins of mankind - Jesus.

God gave this wonderful gift to us and all we have to do to receive it is to believe it! Yes, although it sounds so simple that is all that is required. God asks that we admit we have made mistakes and accept the sacrifice of Jesus on the cross as the way that these mistakes can be payed for so we can have salvation.

The other side of Easter is the resurrection of Jesus from the dead three days after his crucifixion, as He had predicted. This, of course is the total opposite of the grief and hopelessness of the cross. Jesus died as a common criminal, a long, agonizing death. His clothes were stripped off him and gambled for by the Roman soldiers. His disciples fled in fear

NIAD NEWS *and* UPDATES

and all seemed lost as Jesus died on the cross. However, in three days Jesus rose to prove for all time the power of God and to register a defeat to sin and death.

You see, **death is the thing we all fear the most.** Oh, we try to put it out of our minds with all our activities, but it is always there haunting us. We fear death because it represents an end to our existence, a finality that we can't comprehend. We don't know what awaits after death, so we cling on to life with everything we have, attempting to forestall the inevitable.

Jesus' resurrection from the dead showed that *death is not the end* and that we do not have to fear it as the final blow.

Through belief in God and His Son Jesus man can have eternal life, after a physical death. Jesus showed us that we have a Spirit that will live forever in Heaven if we accept the salvation of the cross.

Here is where the sacrifice on the cross and the resurrection come together for all of God's children - if we accept the sacrifice as the forgiveness of our sins we will receive eternal life with God !

Easter represents God's plan of salvation for man - won't you accept the forgiveness of your sins and the resulting salvation provided by the cross ?

God bless you all.

THIS MONTHS INDEX

NIAD NEWS / UPDATES	1
FOR YOUR INFORMATION	3
PUBLIC DOMAIN WORKSHOP.....	6
SMARTBASIC WORKSHOP.....	7
USED/ SWAP CORNER.....	8
TELECOMMUNICATIONS.....	9
CP/M 2.2 WORKSHOP.....	10
ADAM MAINTENANCE.....	11
REVIEWS.....	14
(INVOICER, ADDICTUS)	
PRODUCT LIST	18
CONTRIBUTORS:	
S. McFarlane, W. Motel, J. Notini, P. Harris,	
A. Hamlett, A. Smith	



From The Editor's Desk:

EASTER is such a special holiday because it symbolizes a newness, growth and rebirth. It marks the end of the darkest months and the start of longer daylight days. It marks anticipation of the warmer months and the fun they bring. It is not a coincidence that God made the resurrection of Jesus mark the beginning of spring - they have many things in common. I hope you read the article on the cover page.

There are a lot of happenings in the ADAM community - new products in the development phase, changes in the ADAM support community and a resurgence of interest in our orphaned ADAM.

American Design Components has expressed a strong desire to reproduce both existing ADAM hardware as well as creating some new ADAM hardware !!

Yes, we now have a real chance to see some new hardware for the ADAM from a major electronics company. We can not afford to let this pass. Please write to American to let them know you are interested in purchasing ADAM hardware. State exactly what hardware you would be interested in and what price you would be willing to pay.

NIAD would suggest that you stress a practical 80 column video board as well as a RGB color video output board as two prime new hardware devices. It is vital that we let American know how many active ADAMites are out there.

Write to:

Gary Lawrence
 c/o American Design
 815 Fairview Ave
 Fairview, NJ 07002

Tell American that you are members of NIAD as well, since we will be talking to them about this venture.

Activision is considering releasing some new games in the ADAM format as well - more great news.

We suggest you see the February and March issues of the COMPUTER SHOPPER to see ADAM listed in their index under the "classic computer" section. Paul Pappas and Faye Deere have some fine articles in these issues that all active ADAMites should read.

Paul Pappas is doing a super job in supporting the ADAM by these series of articles aimed at informing ADAMites of new products, support groups and general information of interest.

ADAM - BETTER IN '89



Notice



=> We very happy to announce that our dear friend **Sharon McFarlane is back** in action again (can't keep a good woman down!).

Sharon has added volumes 51-54 to the CP/M 2.2 Public Domain Library - see descriptions in the CP/M workshop. Also, she has sent us information about "NZ-COM - The Z System", an enhanced CP/M that is compatible with ADAM. Thanks Sharon, and its great to have you back.

=> NOTE: A bug has been found in SMARTAX serial numbers 1 through 14. Please send these back for correction or call Jim Notini for instructions on how to correct the problem (just a one line change).

=> There is still no word from Solomon Swift or Digital Express. We have been in contact with several other ADAM support groups and developers, none of whom have heard anything either.

=> We are very concerned at this point and can only hope that there has been some critical problem that will be resolved soon. We suggest that you hold all direct orders to Digital until you are sure they are back in business.

We are running low on Digital products and currently have no way of obtaining additional supplies.

Several of you have expressed concern about money that has been sent to Digital for products you have not received. We suggest you wait for another month to see if Digital is back in business before pursuing any other action.

=> E & T Software is making great progress on a new **256K memory expander**. Target availability date is early May. Price of the board without chips will be under \$100. Price with chips will depend on current prices.

=> To clarify, you should expect to receive NIAD orders 7 to 10 days from the time we receive the order. This covers our time to write up the order, pick, pack and ship it via UPS. Note that if you are on the west coast, UPS shipping time can be up to 5 days, so you're order will be further delayed. Also, Canadian shipping takes longer

=> NIAD accepts advertising for ADAM products and services. Cost is \$50 for a half page ad and \$75 for a full page ad for one month. Contact us for multi issue discounts.

=> Back issues of the NIAD newsletters are available for \$2 each. These issues contain much valuable information that you can take advantage of.

=> NOTE: NIAD provides a disk conversion service. We will provide disk versions of the following programs for a fee of \$4 each: Buck Rogers, DK Jr., DK, Zaxxon, Dragon's Lair, Family Feud, 2010 Text, Recipe Filer, Best of B.C.. You must send in the game card insert from the data pack as proof of purchase.

=> Panasonic has come out with a new line of dot matrix printers with additional features over the 1080 and 1091i models. These printers are more expensive then the current models. We will have a review next month.



=> Mr. T Software is offering a limited time rebate on several of their products. When you purchase any of the following products from NIAD you will receive a coupon which can be sent in for the amount indicated:

ADDRESSBOOK, BASICAIDE, MR. T SEARCH > \$1.00
AUTOWRITER, TRIVIAPAK, KID'S TRIVIAPAK > \$2.00
OFFER IS GOOD UNTIL 4/15/89

=> NIAD welcomes software developers to submit their programs for us to evaluate for possible commercial sale. Send in your products and ideas to us for evaluation.

=> Our Chicago local chapter meetings are a great to learn more about our beloved ADAM. You have the opportunity to meet fellow ADAM owners, ask us questions and see live demonstrations of new products. We meet here at the store on the second Thursday of each month at 7:30 PM.

=> The **next meeting will be on April 13th**. Note: We always have surprise specials on products as well.

=> If 0389 are the first 4 digits of your member number as printed on your mailing label, this is your last issue. Send in your renewal of \$19 for Third class/ \$26 for 1st class/ Canadian.

=> **We have exercised due care in the preparation of this newsletter. No warranty expressed or implied with regard to the information contained herein is given, either by interpretation, use or misuse. The opinions expressed herein do not necessarily reflect those of the editor or staff.**

NEW PRODUCTS/ SPECIALS

* 64K memory expanders without the 2 required 4464 memory chips - \$27.95

* 64K memory expanders with memory chips installed - \$69.95

* Double sided 360K 5 1/4 inch disk drive - \$259.95

* 720K 3 /12 inch disk drive - \$289.95

* New parallel printer interface w/ address dip switches - \$44.95

* ADAM printer power supply with case & operating light - \$49.95

* Megacopy - \$59.95

* Serial printer interface cables - \$15.95

* SOFTWARE

INVOICER - \$14.95

SMARTAX - \$17.95

ADAM BOMB - \$19.95

EASY as A,B,C & 1,2,3 - \$11.95

FORMATTER II - \$12.95

INVOICER - \$ 14.95

ADDICTUS - \$ 14.95

SPEEDYWRITE SPELL - \$24.95

SPEEDYWRITE SPELL & SPEEDYWRITE word processor

Version 2.0 - \$57.95

BORDERS PLUS (for PRINTWORKS) - \$15.95

NEW PD PROGRAMS - SEE PRODUCT LIST

* The program listing starting on page 14 of the February 1989 Issue #50 had some lines cut off. Following are the corrections needed to make the program operate properly. Also this program is on BNDV-31 if you do not wish to type it in yourself:

```

->100 IF PEEK(260) <> 79 THEN 130
->110 POKE 25431, 15: POKE 25471,15
->130 POKE 24695,15: POKE 16783,15
->260 HPLLOT 244, 25 TO 248, 25: HPLLOT 246, 25
TO 246, 29: HPLLOT 249, 25 TO 249, 29: HPLLOT
253, 25 TO 253, 29
->270 HPLLOT 250, 26: HPLLOT 251, 27: HPLLOT
252, 26
    
```

* The article that was printed in the February 1989 Issue #50 about how a formal meeting is setup on CIS was downloaded from the CompuSERVE Data Library 9 in the Club Section.

* Did you know that the ADAM can be used with a Laser Printer? Well it can. We are currently using our Laser Printer, hooked up to ADAM with a standard Parallel Interface, with SmartWRITER, PowerPAINT, PrintWORKS, SmartBASIC, SmartLOGO and just about any other ADAM program that allows for printing on a dot matrix printer. You can't beat the print quality of a laser printer especially if you are using programs such as PowerPAINT and PrintWORKS.

* We recently received fixes for two programs on BNDV-24, they are MathGraphics and Fantasy. The programs originally ran perfectly, but an updated version of basic was used and therefor caused some problems in the operation of these programs. You can send in your BNDV-24 media and we will

recopy the new corrected volume onto it (remember to include self-addressed stamped return mailer). Also, you can fix the programs yourself by running them under normal SmartBASIC V1.0.

Thank you to James Siler for the fixes and also for the original contribution.

* Here is another ADAM only BBS that is operating in the Milwaukee are:

M.A.C.H. 1

SYSOP: Gary Shoening

300 baud / 8-N-1 / ADAMCastle

9pm-6am 7 days a week

(414) 762-0492

* Here is yet another ADAM only BBS that is operated by the AWAUG ADAM User's Group and is located in Virginia:

AWAUG BBS

SYSOP: Bob Blair

300/1200/2400 baud / 8-N-1 or 7-E-1/ CL Digital

24 hours a day, 7 days a week

(703) 922-5497

* Here is a POKE trick that will help in debugging programs. It is listed in the Hacker's Guide to ADAM V.II and was brought to our attention by N. Lukach: POKE 16148,13 To use this first save your program, then run it, type in the poke and finally list it.

* Dear BASIC WORKSHOP,

The article about graphics by Jim Notini was very interesting. It did, however, contain one mistake. All three programs need to have changes in order for them to be technically correct. I have not worked with CLIPloader so I do not have first hand knowledge as to what the bug in the program does, but I do know about HGRloader and SPRITEloader (CLIPloader has a similar error).

The error is one every programmer should avidly avoid. It is an error that doesn't cause the program to crash when the program is run. OK, enough suspense. The main error in all three programs is that the lomem is set to low.

For HGRloader and SPRITEloader, line 5 should read:

```

->5 LOMEM :27681: POKE 16149,255: POKE
16150,255
    
```

And in CLIPloader it should be:

```

->5 LOMEM :27669: POKE 16149,255: POKE
16150,255
    
```

Also in HGRloader, line 15 through 18 inclusive are not needed. This can be seen by the fact that no calls are placed to these addresses. This assembly code program is needed in SPRITEloader not HGRloader. So what is the fuss about? If you program these routines into the ADAM, both HGRloader and SPRITEloader will run and work as expected. However, when the program is changed, sat to add lines 20 and 30 through 39 in SPRITEloader and you run it again, you will encounter the problems.

List the program and you will find garbled lines of code. Until you make a change, the program works. When you run the program first, it works, then you can list it, see the garbled lines (most probably line 17 in SPRITEloader and line 21 in HGRloader), run it again, it should work, then change

anything in the program, and run it again. This is when things get crazy.

The reason is that an assembly language routine program is being poked above the LOMEM limit and this is in the space used by SmartBASIC. All assembly routines should be poked above the HIMEM limit and below the LOMEM limit.

ED: Thanks Much to Aaron Hamlett

* John Lingrel of CL Digital has completed work on a 20 Meg Hard Drive interface and unit. Currently he is using the hard drive on his BBS and supplying many of the other BBS operators with a hard drive for their systems. The hard drive, as of March 6, only operates under CP/M, but BJ has mentioned on CompuSERVE that someone is working on software drivers for EOS. One more item of note, BJ also mentioned that he will only produce 100 units and after this number is reached someone will have to purchase the manufacturing rights to the unit from him in order to keep this unit available. If you are interested in connecting a hard drive to your ADAM, I would highly recommend contacting BJ on his BBS (216) 882-4720.

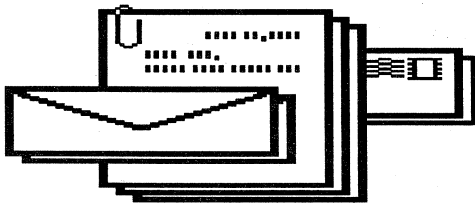

* I have been a member of NIAD for a long time, and have learned much from past issues. I also have bought a few items from you, and have had answers to several letters I have sent asking questions about specific problems I encountered in using ADAM.

Thank you very much.

But I get less and less from your bulletin these days. I don't think it is because I have learned everything about our computer, for I still am an ignoramus about it. And I wonder why I am becoming disillusioned, about NIAD (and not ADAM).

It seems to me that you now are primarily concerned with games. Though I have zero interest in them, I realize there are lots of people to whom computers are primarily toys and games. No doubt you have to cater to them.

But are they the primary users of ADAM? Or are games the only things worth writing about for ADAM users? Oh, I know you told us about SPEEDYWRITE, and have tips on using it; and I recognize you carry stuff about several utility items as well as some hardware. But I feel a lack of the type of things I used to see in the bulletin.

Does anyone else tell you they are losing interest in NIAD? Should you be trying to learn if you still are supplying what most (or a large proportion) of the users want? Can you tell how important games are to the average member? Or modems? Or utilities (they have mostly disappeared from

the last issue of the bulletin)?
I'm not complaining, - just asking.
Regards, Ellis S. Taff

ED: I appreciate your letter and comments. I have looked at the last years issues and there are more reviews of games then other products. However, I think this is just a result of the fact that there have been more games released then other types of programs.

NIAD will review all new products as they are released and give equal coverage to them. We have spent a lot of issue pages on the quality utility programs available as well as the great productivity programs released in the last year.

We would be happy to receive suggestions on other topics members would like to see covered in the newsletter. Please send specifics to us. NIAD is here to serve the needs of its members, we just need to know what they are.

You may want to review the NIAD Member survey results published in the September/ 88 issue. These results are what we are trying to gear the newsletter to. It is obvious that we can't be the perfect newsletter for everyone - each person has their individual priorities for the use of their ADAM. We do try to meet the collective needs of all our members (or at least the ones who write and tell us what they want to see in the newsletter) so that everyone will find something useful in every issue.

Ellis (*and every NIAD member*) please let us know what kinds of articles you would like to see us publish - NIAD wants to provide these to you.



In the February issue of COMPUTER SHOPPER, Ms. Faye B. Deere noted some address changes that would remove the 'rem and data' space bug. Also if you have read this issue you may have noted some other changes involving CATALOG and INIT. These pokes correctly initializes the directory block k with the correct number. The following changes are:

- = For a standard DDP- poke 25305,0 poke 25306,1
- = For a floppy DDP- poke 25305,128 poke 25306,0
- = For a standard disk-poke 25305,160 poke 25306,0
- = For a double sided- poke 25305,64 disk poke 25306,1

T

he default value listed in address (catalog) 25308 is 1. By changing the value to 2 or 3 one can enlarge the amount of files that can be stored.

However, as Ms. Deere noted if anyone has used **BACKUP+3.0** to alter their BASICTAPE then these changes will not work. Ms. Deere listed the pokes needed as follows:

- = Standard DDP- poke 58,0 poke 59,1
- = Floppy DDP- poke 58,128 poke 59,0
- = Standard disk- poke 64,64 poke 65,1

Directory change- poke 25311,2 or 3

Ms. Deere's commit regarding BACKUP+3.0 is correct. I have made so many copies of BASIC using BACKUP+3.0 that somewhere along the line the original BASIC has been lost. If I were to use the poke, peek and call list prepared by Mr. Sharon McFarlane, some of the address changes would not work.

With this thought in mid I have taken Ms McFarlane's list and peeked into all of the addresses that appear on her list noting the following changes.

Address	McFarlane's List	Backup 3.0
16150	255	211
16247	63	112
16641	8/4	40
16776	255	1
16797	255	66
20619	104	72*
25305	255	181
25306	0	65
25308	1	57
64701	189/252	195
64755	243/252	195
64758	246/252	195

* This is an H file and is my change, not Backup 3.0

Note: address 25308 (init directory size) becomes 25311 using BACKUP+3.0.

I don't know if this information could be of any use but, if nothing else you might find it interesting.

A big thank you to Ms. McFarlane and Ms. Deere for their contributions.

Sincerely, Allen Smith

ED: A big thank you to you for your information, which will help other ADAMites - this is what it is all about, many people sharing information through a common source.

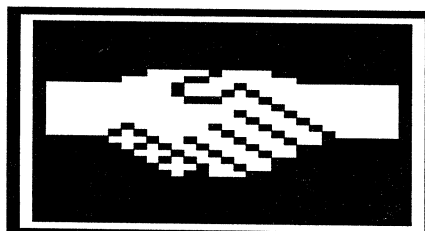

AUG REVIEWS

This is the continuation of the article started in the February Issue #50 newsletter. Hope this helps you in finding groups in your area or just to be in touch with another source of information.

ADAM INTERNATIONAL NEWS

This publication was formerly known as gHAAUG. A.I.M., for short, is one of the oldest ADAM publications. It started as a local paper and it now has one of the largest national circulations of any ADAM newsletter. A wide range of topics are discussed from a technical corner to product reviews. ADAM'S HOUSE also has a large selection of products for the ADAM including system repair.

FREQUENCY: 10 times per year
ANNUAL RATE: \$20 USA / \$22 Canada
EDITOR: Terry R. Fowler
PUBLISHER: ADAM'S HOUSE
OF PAGES: 16-20
STARTED: January 1985
OF ISSUES: 40
ADDRESS: ADAM'S HOUSE - Route 2, Box 2756 -
 Pearland, TX 77581 - (713) 482-5040

AWAUG

This is another newsletter which started by concentrating on it's local members. It is now available nationally as well. Each issue contains a variety of original articles and programs on EOS and CP/M. The group also operates an electronic BBS.

FREQUENCY: Monthly
ANNUAL RATE: \$15 USA
EDITORS: Bob Blair & Peter Hartzler
PUBLISHER: AWAUG
OF PAGES: 16-20
STARTED: June 1984
OF ISSUES: 53
ADDRESS: Bob Blair - 7814 Worthing Ct. -
 Alexandria, VA 22310

463 ADAM

This is a monthly newsletter primarily for members of the local 463 AUG. I'm not certain what the cost would be or if they even accept national memberships, but if you're interested (or particularly if you live in the area), you might want to contact Mr. Roades for details.

FREQUENCY: Monthly
EDITOR: Dean Roades
OF PAGES: 6
ADDRESS: Dean Roades - 8522 Hohman Avenue -
 Munster, IN 46321

P.D. WORKSHOP

SOFTWARE EXCHANGE PROCEDURES

NIAD supports a software exchange for all members in order to supply public domain non-copyrighted programs. Libraries will be maintained for each of the major software products by a NIAD member. Current librarians are:

SmartBASIC V1.0 >>>>>>>>> Jim Notini
 SmartBASIC V2.0 P.O. Box 1317
 Utilities Lisle, IL 60532
 SmartLOGO
 Pinball Games
 RLE Graphics
 PowerPAINT Graphics

SIGNS (SignSHOP/NewsMAKER) >Mike Keith
 P.O. Box 368
 Fredericktown, MO 63645

VideoTunes SONGS >>>>>>>>> John Silva
 69 Sycamore St.
 New Bedford, MA 02740

CP/M 2.2 & All libraries for >>>>> Sharon McFarlane
 Canadian Members Box 186, Etobicoke P.O.
 Etobicoke, ONT., CAN.
 M9C 4V3

SOFTWARE EXCHANGE RULES:

You have the option to purchase a specific library for only \$4.00 (on disk) or \$6.00 (on ddp) from the NIAD Product List if you don't have a program to exchange.

The public domain library is made up of volumes (individual tapes or disks) that contain from 10 to 30 individual programs. In order to receive all the programs on a certain volume from the library, send a disk or data pack with the program you wish to submit into the public domain (all programs should be tested and well documented via a separate 'readme' file prepared in SmartWRITER) to the librarian. Include a self-addressed and STAMPed return mailer. The librarian will copy the volume number that you specify on your disk or ddp and return it to you. You must submit the same type of program as the volume you are requesting (ie, send a basic program to get a basic volume, send a CP/M program for a CP/M volume, etc.). Additionally, you may submit NON-COPYRIGHTED programs from books or magazines, except FAMILY COMPUTING MAGAZINE. One more item of note, the program or picture file cannot already be in one of the public domain volumes already distributed by NIAD.

NEW PUBLIC DOMAIN SOFTWARE

A-CHESS (SARGON)

This chess game first appeared in the CP/M public domain a few years ago, but was 100% text. Now, thanks to Chris Braymen, we have another chess game that depicts the chess board and all the pieces (kings, queens, bishops, etc.) on the screen. Although the graphics and detail aren't as good as Chess Champ by DEI, the computer plays a real mean game. To load, place media in the disk or data drive and pull the computer reset. The next screen will display the message CP/M loaded, please wait for prompt. If you wish to read the documentation file, press SmartKEY IV (SCNCHOP) to set the screen output to 30 characters. Then press SmartKEY V (TYPE DOCS) plus <RETURN> to load and display the documentation. Finally, press SmartKEY II (A-CHESS) to load the game. This is truly one of the best public domain programs that we have in our library, for the price of \$4 on disk and \$6 on ddp, this is one heckuva bargain.

THE ANIMATOR

The Sprite Animator is a full fledged sprite development package that was developed in SmartBASIC V2.0 by Joe Waters. You can develop up to 20 independent sprites, save and load them, manipulate them and even animate them. The program is auto-booting and takes a few minutes to load from disk or ddp. Read the Readme-1st file for further details on how to use this program.

SPEED CHECKER (For Disk and Data Drives)

This is a program that was developed by Coleco to test the operating speed of the disk and data drives before they were sent to retailers. You simply place the media into either data drive #1 or disk drive #1 and pull the computer reset. After about one minute, the Percentage Screen should appear with percentages from -6 through +6. This is a good utility to test how well your drives are performing. Read the SPEEDTSDOC file in SmartWRITER for further details on how to use this program and also how to spot any problems.

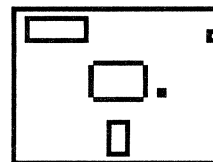

SmartBASIC WORKSHOP

NIAD PUBLIC DOMAIN

--- *SmartBASIC VOL.# BNDV-32* --- PROGRAM DESCRIPTIONS

- HELLO - Loads and runs the menu program.
 MENU - Displays all basic executable programs with the option to run.
 ChainReact - Eliminate all your opponent's pieces from the field of play. (2 player game)
 DiffCalcul - A calculus program to differentiate algebraic, trig, hyperbolic, etc. functions.
 Ez-Calendr - A great DEI PD program that creates calendars on the HGR screen. Uses SmartKEY input.
 Ez-Copy - A DEI PD program which will make backups of disks/ddps with standard or special copy options. Uses SmartKEY input. Great!
 Ez-File-TR - A DEI PD file copy program which will copy any EOS type file. Must have at least 2 drives.
 Ez-Keys-II - A DEI PD program which sets up certain keys as macros and setup keyclick. NOT COMPATIBLE WITH MENU PROGRAM LISTED ABOVE.
 Ez-Menu - A DEI PD program for running, renaming, initial-izing, etc. Uses SmartKEYS on the HGR screen.
 Ez-Patch - A DEI PD program for altering SmartBASIC. Allows for the writing of many fixes directly to the Smart-BASIC file on disk or data pack.
 JoinFour - Classic game of join-four where one has to connect four blocks in a row either horizontally, vertically or diagonally. Press 1-9 to select which column to drop block. 2 players only.
 JumpJack - Jump over holes to reach the ladder and descend to the lower platform to move onto the next level.
 SimplePNTR - A DEI PD program which allows for the loading, saving, changing of colors, enlargement and printing on a dot matrix printer of SmartPAINT pictures.
 Z80-Dsmblr - Another Z80 Disassembler, but one of the best ones in the public domain to date. Uses SmartKEYS
 tbl - Data file for Z80-Dsmblr.
 NiadBNDV32 - Brief descriptions of all the files on this media.

TOTAL OF 16 FILES WITH SmartBASIC 1.0 = 157K

I would like to thank all those who have contributed to the NIAD Public Domain over the past years. Of late though, we have only heard from a handful of members who have sent in p.d. software. Come on people, let's send in those programs and let other people get a chance to use them. If your program is good enough, who knows, maybe it will be released commercially!

RECENT CONTRIBUTORS: H.M. Guill, Dan Fraser, C.R. Woolums, Sol Swift/Digital Express
 David Graf, Ken Stonebrook,
 Terry Fowler/ADAM'S HOUSE

Ez-Menu

This program is rife with advanced features, various sounds, SmartKEY labels, drive status checks, fast hi-res characters. You can use it to CATALOG, INIT, RENAME FILES or VOLUME NAMES, RUN and BRUN programs (it automatically determines which is necessary).

Ez-File-TR

This program will copy files from one medium (disk, ddp or ramdisk) to another. It will copy files of any length, even deleted files. It automatically locks the copied file and it copies the files image, ie, if the original was a binary converted file (H), the copy will be too. It will copy any type of file (SmartWRITER, Basic, Binary, Machine Code, etc.) You must have at least two drives be it disk, ddp or use of a ramdisk.

Ez-Calendr

A program based on the perpetual calendar. This one draws the actual calendar for the specified month and year on the HGR2 screen. You can exit the program leaving the calendar on the screen. This allows you to use the Pix.Mgr program on BNDV-31, PowerPAINT or ShowOFF-I to save the graphic calendar as a SmartPAINT or HGR file. Then you can print or edit the calendar with PowerPAINT or ShowOFF I. You can also print the screen with SimplePNTR (see below).

Ez-Keys-II

Adds five keyclick sounds in immediate program mode. SmartKEY VI will change the default drive to Walters' Soft. RamDISK I. Also, you can press SHIFT-CLEAR to execute a text command. SHIFT-STORE will check to see if DEI's Intel-LOAD V1.0 is in RAM and call address 56320. There, however, isn't any on/off feature.

Ez-Copy

Includes an 'auto' copy option which calculates the number of blocks to copy, it will work with 1,2 or 3 block directories, copy supergames and CP/M software with the 'auto' feature and automatically copy all the blocks. Also, included is a home media feature that you can turn on or off, a block fix feature which is used when you are copying data packs to disk and vice versa, specialized copying is used to set the first and last blocks to copy at your preference.

SimplePNTR

This is the only free distribution program for the ADAM that will print hi-res graphics on a dot matrix printer. Also, it will enlarge graphics on the screen. SimplePNTR will store pics in Basic HGR or SmartPAINT format and load Basic HGR, SmartPAINT, RLE and PowerPAINT format!

USED / SWAP CORNER

NIAD will be selling used items that we have purchased from ADAM owners. Additionally, members may send in lists of items they want to sell or trade with other members.

We have a few of each item available, we will have to restrict orders on any of the products listed below to phone orders (first call, first serve). If we do take mail orders, it would become a terrible mess. For example, we might receive two orders on the same day for the same product and only have one in stock. So you see that it would not be fair for the person that we don't sell the product to. So please, as they say on the commercial: **PHONE FIRST!** If we do receive any orders through the mail, we will promptly return your order.

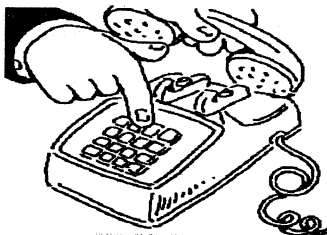

CARTRIDGES

Brain Strainers	\$10
Campaign '84	\$10
Carnival	\$10
Fraction Fever	\$7
Jukebox	\$10
Logic Levels	\$8
Monkey Academy	\$10
Super Action Baseball	\$10
Telly Turtle	\$10

FLASH! FLASH! FLASH! FLASH!

If you have anything for sale (software, hardware or supplies, etc.), send in a list of what you are selling and the prices you are asking and we will list it in this column for you at no charge. Please do not send items into us without confirming with us first.

SOFTWARE

2010: Text Adventure	\$12
ADAMCalc	\$12
Best of Broderbund	\$10
Expertype	\$10
Flashcard Maker	\$10
Flash Facts: Flashbacks	\$6
Flash Facts: Trivia	\$6
Packcopy	\$6
Recipe Filer	\$7
SmartFILER	\$8
SmartLETTERS & FORMS	\$8
Strategy Strain (DISK)	\$8
Super Zaxxon	\$7

HARDWARE

Tan Joysticks	\$3
Keyboard Attachment w/ Tan Joystick	\$6
Keyboard Attachment	\$3
Keyboards	\$10
ADAMnet Cable (Coiled)	\$1
Magnavox 80 Column Monochrome Monitor	\$75
Amdek Amber Monitor	\$60
ADAM Daisy Wheel Printer	\$75
ADAM Daisy Wheel Printer with Tractor Feed	\$120
Address Book w/ AutoDialer	\$20
Roller Controller w/ Slither without Power Adapter	\$30
Atari Disk Drive Dust Cover Fits ADAM Drive	\$3

ATARI 2600 CARTS

Asteroids	\$5
Boxing	\$5
Cosmic Ark	\$5
Defender	\$5
Demon Attack	\$5
Empire Strikes Back	\$5
Haunted House	\$5
Riddle of the Sphinx	\$7
Robot Tank	\$5
Smurf Rescue	\$5
Spiderman	\$7
Star Raiders w/Keypad	\$10
Star Voyager	\$5
Super Challenge Baseball	\$5
Venture	\$5
Yar's Revenge	\$7
Warlords	\$5

FOR SALE

Complete ADAM System with PIA-2, 64K Board, Exp. Mod. #1, #2 & #3, Roller Controller, extra joysticks with keypad (WICO), tons of great software 160K Disk Drive like new: Greg McDaniel, W: (312) 571-1119, H: (312) 691-8320 or NIAD c/o Greg McDaniel

Colecovision cartridges for sale. Many titles, but would prefer to sell them all together instead of breaking them up
Contact: Dennis Fleenor, 8634 Green Branch Lane, Indianapolis, IN 46256
At home after 6:00 call (317) 577-7403

ADAM Power Supply with Cover (\$30), ADAM Computer with Printer and 1 Data Drive (\$180), R59 ADAM Computer with Printer and 1 Data Drive (\$150), 64K Memory Expander (\$50). Contact: Robert Kologe, 56 Woodruff Ave., Thomaston, CT 06787 or call (203) 283-9631.

ADAM Computer System for sale, all original items included with original box and with dust covers. Contact for pricing: Mark D. Wall, 1340 10th St., Spearfish, SD 57783 or call (605) 642-2777.

ADAM Computer with Printer, Disk Drive, 2 Tape Drives, Driving Module and assorted software, cartridges and books. Contact: Cynthia Crisp, 2417 Haile Street Ext., Camden, SC 29020

Standalone ADAM Computer and an Expansion Module #3 with Coleco-Vision, Thompson Monochrome Monitor, 2 Disk Drives and numerous software packages for sale. Contact: Robert Keller, 429 Oak, DeKalb, IL 60115 or call (312) 756-1420.

Complete ADAM System with monitor cable, 64K Memory Expander, 13" 80 Column Monochrome Monitor and some software. Asking \$350.00. Contact: Ovidiu Sfarocci, 2453 N. Kostner #1, Chicago, IL 60639 or call (312) 763-0343 after 4:00 pm.

Complete ADAM System for sale. Contact: John Wong, 132 Russ St., San Francisco, CA 94103

TELECOMMUNICATIONS

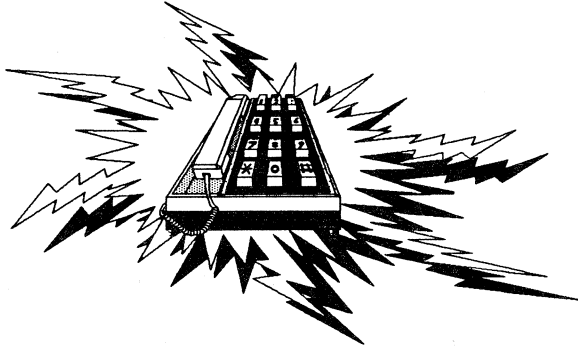

What CIS Offers ADAM *By Jim Notini*

CompuServe has been supporting the ADAM Computer for the past 4 or 5 years now and through the years the ADAM support has fluctuated from near non-existent to a flood of ADAM supporters on the service. Since one of NIAD's Christmas specials was a free modem, I would have to assume that there are many modem owners out there that aren't sure what type of system they should join up with or if they should just continue calling long distance to their favorite BBS system. The entire point of this article is to walk you through the services provided by CIS for the ADAM (only the ADAM, CIS offers a wide range of services which was briefly touched on in the Dec/Jan issue of NIAD. The following are brief description of each area in the Computer Club section of CIS. I hope this helps you in deciding if you want to join up CIS's service and to see if they have what you are looking for.

WHAT IS A FORUM?

A CIS Forum is a set of communications tools which together create a unique environment where you can exchange information with a group of people who share similar interests. For example, you can join in debates and conversations on the message boards by reading and leaving public messages. You can also talk to people more directly using the CONFERENCE system. Two or more people in the same online conference room can hold a live conversation, even if the participants are located halfway around the world. Libraries enable members of most Forums to share reports, software, spreadsheets, reviews, etc. In addition, bulletins may be posted concerning Forum information and events. Forum members may also choose to list themselves in the Member Directory. Finally, you can customize many parts of the Forum to suit your needs and preferences. If you have any problems, there is extensive help online to aid your use of the Forum.

MESSAGE BASES:

The messages portion of the Forum is an area where members use messages to correspond with one another. Here you may find person-to-person notes, answers to

questions, and ongoing discussions. You can post your own messages, reply to other messages, or just read messages posted by other members.

LIBRARIES:

The Libraries portion of the Forum is a resource area containing programs or text files. Here you may find transcripts from online conference articles, professional reports, news and reviews. These materials can be read online or downloaded to your computer for lasting reference. You may also find a range of useful software (public domain, shareware, and freeware) that you can download and add to your personal computer library.

CONFERENCING:

Conference rooms are areas where members gather for live conversation. Here you may find several members engaged in a regularly scheduled meeting or participating in a special conference hosted by a guest speaker.

ANNOUNCEMENTS:

Announcements are written by the Forum Sysop and designed to keep the Forum members apprised of scheduled events, hot topics, new uploads, and generally useful information. There are two announcements that are automatically displayed if you haven't read the latest edition. The News Flash is displayed when you first enter the Forum, the Conference Announcement is displayed when you first enter the Conferencing area.

MEMBER DIRECTORY:

The Member Directory is an area where members voluntarily enter their interests. If you are in the menu mode, you will be greeted with the member directory menu, which lists several choices for using the Member Directory.

OPTIONS:

The options area is where a member can set Forum and Messages Options. After making changes in the options area, you will be given the chance to make the changes permanent or temporary for session only.

MISCELLANEOUS:

There are various other commands that you can enter at any Forum menu/prompt. Entering WHO will display information about a particular member. Entering UST will give you a listing of the members who are currently in the Forum. You can also SEND a short one-line message to any user who is currently in the Forum.

OTHER SERVICES:

Some other services which might be of interest to ADAMites is the large library of picture files which are stored in RLE format. RLE stands for Run-Length Encoded and has become a universal standard for picture storage among the various computers. What this means is, if you have software that will allow you to download (AL II, AL III, SmartTERM or one of the CP/M packages) you have access to an vast amount of graphic pictures!



CP/M WORKSHOP

NIAD CP/M PUBLIC DOMAIN LIBRARY

Compiled by: Sharon McFarlane January 10, 1989

→ CNPDVOL.051

- * DBL-401 .ARC Print ASCII Files in 2-Columns/Compressed Print. Latest Version.
- * EXPRESS .LBR Full Screen Text Editor. Extensive DOC Files. Sample Version 1.0
- * FANFOLD5.ARC Print Text Files on Both Sides of Paper! Useful for Large Files.
- * FILT-7A .ARC Filters out any/all Control Codes. Sets Tabs in ASCII/ASM Files.
- * FINREP28.ARC Search/Replace Utility. Fixes WS's ^QA Deficiencies. Very Fast!
- * HRD/SFT .ARC WS Utility. Transfer Non-WS Formatted Text Files to -or- from WS

→ CNPDVOL.052

- * APPEND .ARC Append "A" File to "B" File.
- * CHOPVDE2.ARC Chop Large VDE/ASCII Files into Smaller Ones for Easier Editing.
- * DICTNU .LBR Checks any ASCII File for Diction Errors. Update to DICTION.LBR.
- * LABLDISK.ARC Create Disk Labels quick 'n easy.
- * MAGE31 .ARC Recover lost WS files after 'Disk Full Error'.
- * DB2MENUS.ARC Create 'Menus' for dBase II Applications.
- * SYA13 .LBR Save Text File when WordStar 'crashes'.
- * WSRESQ14.ARC ...and yet another Utility to save WS Files after system failure
- * WSTWOCOLARC Print WordStar Files in 2-Columns.
- * WSUTIL-1.ARC Useful Utility package for WordStar Version 3.3

→ CNPDVOL.053

- * ALPHATXT.ARC Text Formatter with unusual features/User defined printer codes.
- * IMAGEPRT.LBR Fantastic, full-featured Epson/Panasonic KX-Series printer pgm.
- * PAN1091 .COM Panasonic KX-P1091 printer utility.

→ CNPDVOL.054

- * VDE266 .ARC Small but powerful Text Editor. Latest (last?) Version.
- * VDE266 .FIX Version 266 bug fix - released by Author.
- * VDE266SP.LBR Screen Writer's patch/add-on to VDE 266.
- * VDEHELP .LBR Comprehensive 'Help' files for VDE 266.

SOFTWARE SOURCE FOR CP/M 2.2 AND 3.0

=====
 Revision B -- all prices, phone #'s, and addresses verified as of 4/15/88.

I wish to acknowledge the efforts of the previous author who compiled the original list (CPMSRC-A.LST). Without his/her efforts this revised list would have been much smaller. If anyone comes upon a new source for CP/M software or books on CP/M I would appreciate a message listing name, address, phone number and what they are offering for sale left as a message on one of the following BBS's or Genie.

- ECCUG BBS - (203) 228-1031 -> handle = Altariel
- CONNHUG BBS - (203) 673-8752 -> Brian Marcotte
- The Fireplace BBS - (203) 448-1349 -> Brian Marcotte
- Genie Information Network -> GE Mail Address = B.MARCOTTE1

I have attempted to verify the continued existence of the following companies, and their continued support of CP/M. I have indicated successful verification by placing **** Verified **** at the end of the companies listing. I have included some unverified companies in this list in the hope that someone out there can provide me with this information. Your help in fleshing out this list will be appreciated by all the people who make use of this list.

Agricultural Software Consultants, Inc.
 1706 Santa Fe Catalog available
 Kingsville, TX 78363 (512) 595-1937
 * Verified *

Alcor Systems
 1132 Commerce Dr.
 Richardson, TX 75081 (214) 226-4476

Alpine Data Income 635 Main St. Montrose, CO 81401 (303) 249-1400 (800) 525-1040 * Verified *	Tax program Depreciation Schedule prg. Brochures available
-----------------------------------------------------------------------------------------------------------	------------------------------------------------------------------

The Cedar Mill Z-Node 12275 N.W. Cornell Rd. Suite 5 Portland, OR 97229-5611 (503) 641-6101 (8:00 - 22:00 PDT) (503) 644-4621 (BBS Number - 300,1200,2400 baud; avail. by PC Pursuit) * Verified *	Complete CP/M line if it's not listed, ask for it Catalog avail. for D/L fn = PRICES.DZT (short file) PRICES.TZT (long file)
----------------------------------------------------------------------------------------------------------------------------------------------------------------------------------------------------------------------	------------------------------------------------------------------------------------------------------------------------------------------

Centennial Software, Inc. REALFOCUS - Real estate package
 1873 S. Bellaire St. Suite 510
 Denver, CO 80222
 (303) 691-5586 --> phone rang but no answer

... Will be continued next month.

ADAM MAINTENANCE

PART 2

Last month in this column we gave some instructions on solving some common ADAM hardware problems through preventative maintenance. This month we will give you more trouble shooting hints and some great "Tips & Tricks" to keep your beloved ADAM running in top notch fashion.

COMMON ADAM PROBLEMS

The list below are the more common problems and their solutions. This is by no means a complete list, but does contain the more prevalent problems that many ADAMites run into.

If the solutions do not work, then you may have a more serious hardware problem that will require repair by one of the ADAM repair houses (see below).

→**SYMPTOM:** Strange patterns on the screen and other erratic problems

SOLUTIONS:

1. Turn off the ADAM and disconnect/ reconnect all cables three times to insure a good connection exists.
2. Insure good ventilation to back of the printer and memory console to prevent over heating.

→**SYMPTOM:** Printer hangs up and "buzzes" when system first turned on.

SOLUTIONS:

Turn off the ADAM and roll the printer platten advance knob back and forth to free it up.

→**SYMPTOM:** Print head moves to one side and "bumps" continually against the side.

SOLUTIONS:

Turn off the ADAM, refer to figure 8 and bend the carriage return contacts so they are parallel and touch as indicated. See figures 8 - 10 below.

NOTE: If you have a new style ADAM printer (the print head is a black cylinder, rather than the silver rectangle), a different carriage return switch is used and does not require adjustment as described here.

→**SYMPTOM:** No screen display when the ADAM is first turned on.

SOLUTIONS:

1. Check cable from ADAM to TV or monitor.
2. Check all cable connections.
3. If a tape drive was just installed, connectors were not installed correctly - see figure 6B.
4. After ADAM is first turned on, type using keyboard - if printer works, then problem is in the ADAM video display or the TV/ monitor.

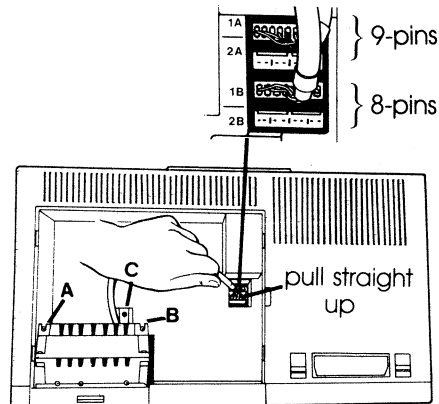

(Fig. 6B) Data Pack Drive Removal

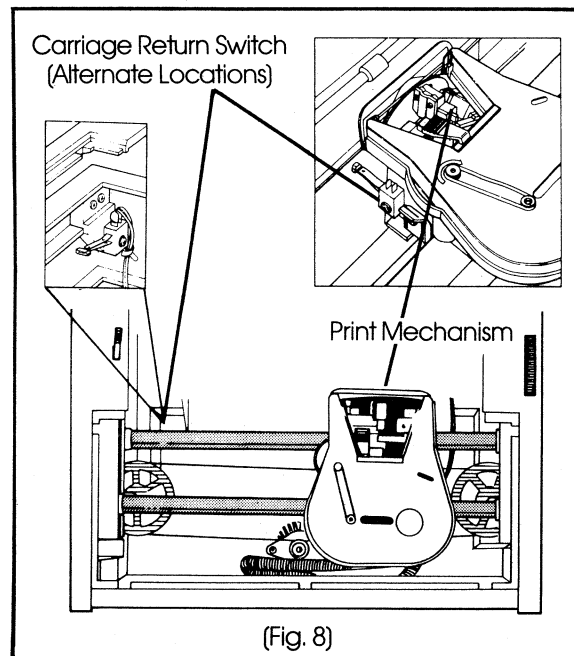

(Fig. 8)

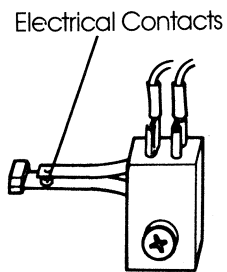

(Fig. 9) Correct Position

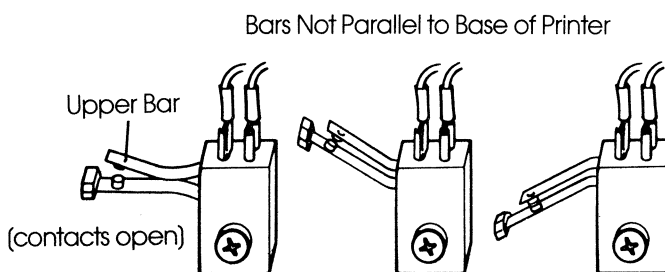

(Fig. 10) Incorrect Positions

Carriage Return Switch

→**SYMPTOM:** During a print operation, the left margin “moves” to the right (ADAM loses track of where the left margin is).

SOLUTIONS:

ESCape from the printing operation, save your document to tape/ disk and turn off the ADAM for 1/2 hour. This problem usually occurs when the printer is overheated after alot of printing.

MIS-PRINTING OF CHARACTERS

If characters are not evenly printing i. e. either the top or bottom half is cut off or faint, the problem may be that the ribbon is not properly inserted in the printer [see your ADAM manual for how to insert the ribbon].

If the above doesn't work then the print head needs adjustment. See see figures 14 through 21 below.

NOTE: The newer printer models do not have the type of print head illustrated below, they can be adjusted via two screws on the left and right that hold the cylindrical print head in place.

After adjustment is complete and checked apply 2 drops of cyanoacrylate glue (Super glue, Eastman 910, or equivalent) as shown in Fig. 16.

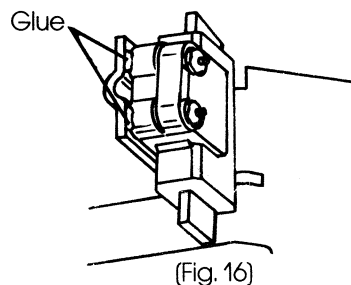

(Fig. 16)

EXAMPLE: oooooo8888

If characters are light on top, adjust hammer assembly slightly forward. (Fig. 15)

When adjusting, grasp hammer assembly with pliers as shown below in Fig. 14.

EXAMPLE: 8888888888

If characters are light on bottom, adjust hammer assembly slightly backwards. (Fig. 15)

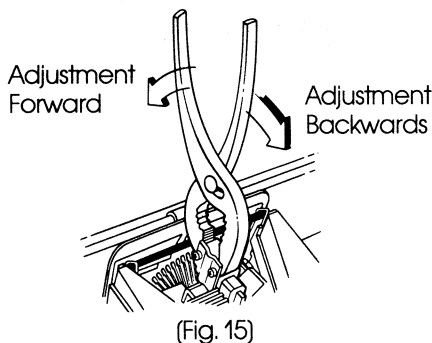
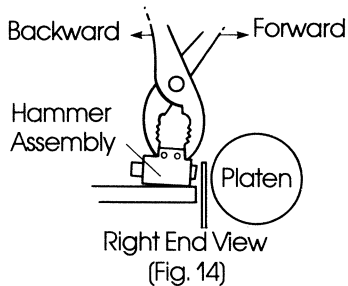

(Fig. 15)

If print displays part of adjoining character or double characters, adjust print hammer in the following manner:

EXAMPLE: d d d } } } } } } } } } } } } } } } } } } } } } } }

- A. Remove printer cover (See note on page 10.)
- B. Turn system on and insert paper.
- C. Press space bar to move print head to center of page. Then press underscore key by holding down the shift key and the number 6 key.
- D. Push the metal hammer striker forward with your thumb and observe if striker is centered on underscore petal. (Figs. 17, 18 and 19.)
- E. If hammer striker is not centered on the daisy wheel petal, adjust slightly as shown in figure 20 until hammer striker is centered. (See Fig. 17.)

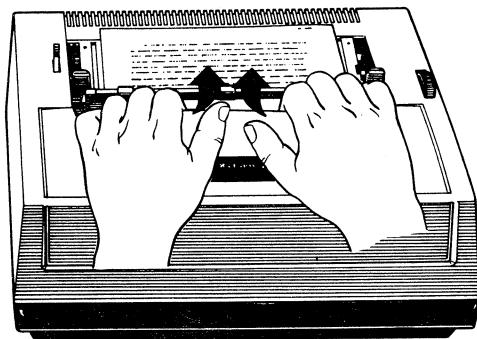
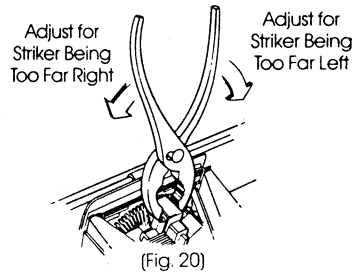
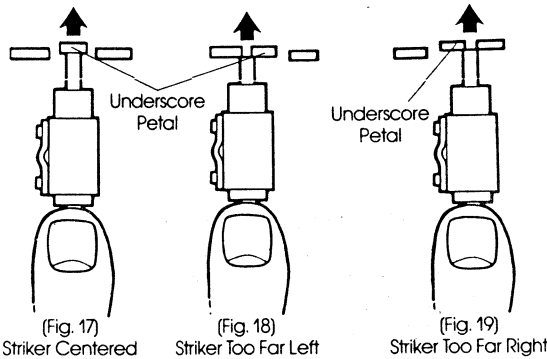

(Fig. 12)

DISK DRIVES

The most common problems with disk drives are ones due to wear and tear on the drive mechanism itself, resulting in the need to have the drive cleaned and re-aligned, if you begin to experience occasional read/write or I/O errors, this is usually the cause. One problem results from using cheap diskettes, that are now readily available. These cheap diskettes can "gum up" the drives read/write head resulting in numerous problems. I recommend a wet/dry head cleaning kit for cleaning your read/write print head every few months, depending on use [NIAD now carries a good disk drive head cleaning kit containing two cleaning diskettes and cleaning fluid]. Other problems are being able to read a diskette, but not being able to write to it. This is usually caused by a bad photo sensor that is supposed to determine whether the diskette has a write protect tab on it [the little notch on the left of the diskette]. There is also a sensor that determines when a diskette has been placed in the drive-if this goes bad, the software doesn't know that a diskette is present. For the common problems described above, you may be able to find a local disk drive service company that will do cleaning and re-alignment for the ADAM drive. Just tell them that it is a MPI drive mechanism [MPI is common disk drive mechanism used in different computer drive units].

REPAIRS

There are two repair locations for ADAM, both of which offer a complete repair service:

ADAM'S HOUSE Route 2 Box 2756 Pearland, TX 77581 (713) 482-5040 Repair of consoles or printers - \$50 flat fee plus \$8 shipping

Kosowsky's ADAM Repair Service is expanding. Hours are 6 to 10PM Monday thru Friday and 10AM to 10PM Sat/Sun. Repairs are available for the:

- CPU console - \$50 + shipping
- Printers - \$50 + shipping
- Single sided drives - \$75 + shipping

Also, any CPU console can be converted to a revision 80 version for \$50 plus shipping.

NOTE: A \$5.00 discount for NIAD members is available for all repairs.

Kosowsky's also has many ADAM parts and chips available.

Kosowsky's ADAM Repair
6067 Jerusalem Drive
Clay, NY 13041 (315) 699-6456

NIAD has new and used consoles and printers available as well that can be used to replace defective units. Call us for current prices and availability.

We'll have more next month plus some tips and tricks.

REVIEWS

WHAT'S HOT IN SOFTWARE SALES ?

The best selling software from 11/16 thru 1/27 By Jim Notini

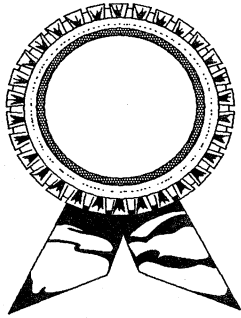

This is a new section which will be running every few months to let everyone know what the best selling programs on the ADAM are. The tallies will not include any software that is offered as a free gift (i.e.: NIAD GOLD series, Home Budget Planner, GraphixPix, etc.), rather I will concentrate on the programs that were purchased through NIAD from a certain date to another date. These totals also will not

include any sales of used software and will be based solely on mail and phone orders.

Our store sales of ADAM software will not be included but, this shouldn't cause much change in the overall standings since the sales for the store are very similar to mail/phone orders.

One more item of note, as you will be able to tell, the newer programs will always have the advantage over the older programs since they have been on the market longer. There really is no solution to this problem without taking it upon myself to do a lot of research and hard work, so the ratings will only be kept from certain periods and not go back any further than the date listed. Also, any programs that are on closeout will not be included in the ratings. We had one program, TURBOLOAD, that would have rated in a tenth place tie with Pro Golf Champ but, had it not been for the reduced price, this program would have never generated the sales that it did.

AND NOW FOR THE RATINGS:

TOP TEN FOR THE PERIOD OF 11/16 TO 1/27

- 1) Temple of the Snow Dragon by Digital Adventures
- 2) PrintWORKS by Walters Software Co.
- 3) SpeedyWRITE V2.0 by White Co.
- 4) Ghost Zapper by Pitman Software
- 5) File Manager V2.0 by AJM Software
- 6) ADAMLink III by Tom Clary
- 7) CopyCART+ 2.0 by MMSG Sub Raiders by Statagic Software Inc.
- 8) PowerPAINT by Digital Express Inc.
- 9) Clipper by Digital Express Inc. Chess Champ by Digital Express Inc.
- 10) Pro Golf Champ by Superior Software

Other programs that were close, but not close enough where: Mind Over ADAM by Pitman Software
 SmartDSK III by Walters Software Co.
 Las Vegas Craps by Al Roginsky Software
 SpritePOWER by Digital Express Inc.
 Clip-Art Vol. 1 by Wizard's Lair Soft.
 RamBOOT by Walters Software Co.

INVOICER) Reviewed by Jim Notini

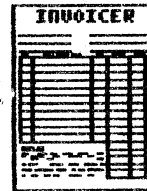

INVOICER is an invoicing and inventory control program which requires the 64K or larger expansion card (the larger expansion boards are used as a 64K Board).

ADAM has long been in need of quality business software and this program meets that need for any small business. INVOICER is not just an invoicing program, but a complete inventory control program with many added features to make it very useful. Terry Fowler developed this program for his own use, which makes it that much more practical.

Up to 500 inventory items may be stored in memory for immediate recall onscreen or stock level adjustment. Inventory is automatically adjusted as invoices are created and typed on an ADAM or Dot Matrix Printer. Listings may be viewed or printed of all inventory, a portion of inventory, or just items in short supply for reordering purposes. As inventory is received, all that is needed to do is to simply adjust the stock levels.

To load INVOICER, simply insert the media into a drive and pull reset. A menu will be loaded which asks if you want to view the instructions or continue loading the program (there is also an instruction manual included with the program). Upon choosing to continue loading, you will be presented with another menu which asks if you are using a dot matrix printer or the ADAM daisy wheel printer. Also, if you do not have a memory expander installed in your system, you will get an OUT OF MEMORY error and will not be able to continue on.

Once the main program has loaded, you are asked the current date and also if you are using a dot matrix printer. After this the main menu is displayed with the following options:

- STORE/GET KEY = CATALOG MEDIA
- (C)OPY DATA INVENTORY
- (E)NTER/LOAD INVENTORY FILE

- (I)NVOICE PROCESSING
- (Q)UIT PROGRAM and
- (V)IEW INVENTORY.

When you first start, you will want to create your inventory. For each inventory item you will have to enter it's cost, sales price, quantity in inventory and name. The stock number is automatically assigned beginning with 101, but can be changed to suit your needs. When you have finished entering in the inventory, you will want to save the contents of the inventory onto a physical drive so as not to take any chances in loosing this data and also for future use. When you continue to enter in more inventory, the number is automatically increased by one so as not to overwrite any of your previous information.

One also has the ability to view each inventory item with all it's prices and change any of the categories as needed by using the CHANGE option from the ENTER/LOAD INVENTORY mode.

With the VIEW INVENTORY option, you may view or print listings of low level items, all inventory items, you may also choose a beginning stock number to start at or you may display an inventory item onscreen with the cost of the item, price, quantity in stock, the name and stock number. Printed out listings will include the item name, the total cost value, the retail value and the number of items in inventory.

By choosing (I)NVOICE PROCESSING, you will be prompted to enter in the name of the purchaser, address, how the order was paid, was it taxable (the set percentage can be changed), membership fee, credit or debit, shipping fee (also can be adjusted), and discounts, etc.

You are also given the option of writing a four line note to the person which comes in handy more times than can be realized and also a coupon can be printed with the invoice if needed.

After this process, you are prompted to enter in the item numbers and quantities that where ordered. Once this is complete, the invoice is printed on the screen and also to the printer for a hardcopy. If everything is in proper order, you are asked if another hardcopy is needed, and finally there is an option to print out a third copy of the invoice for filling purposes or any other need.

Now you may continue entering invoices or return to the main menu. Remember, after doing any type of work on the inventory or invoice processing, *save the contents of memory (the inventory) back to a disk or ddp before ending the program or else a lot of work will be lost.*

All told, INVOICER is a very handy software package for those operating a small business or personal business. It does the job very well and surprisingly fast.

This program was actually completed over a year ago by Terry Fowler and was being used for his group (GHAAUG/ADAM HOUSE/A.I.M.), but was under going heavy testing and quite a few additions.

One function that I personally would like to see added is the ability to sort the inventory in alphabetical order for hradcopy purposes. I find it a lot easier to look down a list of letters rather than a list of numbers, especially if I don't know the items number. Hopefully this is something Terry will take into consideration and offer if he decides to upgrade the program anymore.

One more note, Terry Fowler has left the program wide open so that you may actually list it out and customize it to your own personally needs. I say bravo to Mr. Fowler on this decision since a lot of people complain that there application programs just don't offer or are setup they way that they need them to be.

RATING - A+
HIGHLY RECOMMENDED

ADDICTUS Reviewed by Jim Notini

Addictus is Reedy Software's latest game release and let me tell you, IT DOES BECOME ADDICTING! Addictus requires quick thinking and skillful hand-eye coordination. The player is presented with an empty pit. One by one, different shaped blocks will drop into the pit. The ultimate goal of the player is to prevent the pit from overflowing: when the blocks stack up to the top, the game ends.

The player has a couple of different ways of manipulating the ever-falling blocks. By using the left and right arrow keys as the block is descending, you can move the block in that direction. Pressing the down arrow key will cause the block speed to increase, this is used

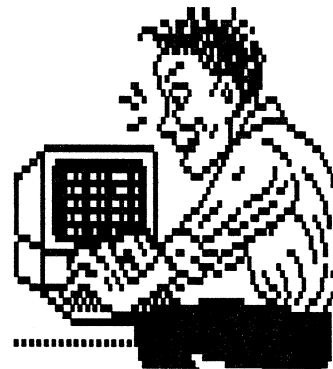

if the block is above the spot that you want it dropped into. The HOME key will rotate the block which allows one to fit the block into tight spots. The player should attempt to fit the blocks in as tightly as possible, leaving as little blank space as possible. When a horizontal row is completely filled, that row will disappear and the rows above it will fall down which will leave more room for additional blocks (and possibly uncovering previously covered blank spaces).

As the manual says, "the skilled player will find that he or she can keep one game going for several minutes." I myself, was only able to keep it going for about 3 or 4 minutes, so it won't be a game that is easily defeated and therefor it will retain it's value a lot longer than most games.

Addictus is available on disk or ddp and is totally auto-loading (put the media into the drive and pull reset). As with all Reedy Software's programs a title screen will be displayed as the program loads into memory. Once loaded, another title screen will be pieced together by falling blocks (very nice effect) with the dot for the "i" in Addictus bouncing up and down waiting for an input from the user.

When the game begins, you will be presented with a screen that contains the 'pit' (or section where the blocks drop down) in the center of the screen. On the left side is a list of the HIGH SCORES. The list can hold the top 20 scores and is updated after every game so that the high scores will always

be current for each time you play Addictus. On the right side of the screen is displayed your current SCORE, the number of LINES (number of eliminated rows), NEXT displays what the next block will look like, giving the player a chance to plan ahead.

As you progress further and further into the game and more lines are eliminated, the difficulty of the game will increase (the blocks will fall faster). At every increment of 10 lines eliminated, a noise effect will sound telling you that the difficulty level has increased.

All told, there are 10 difficulty levels. The main goal, therefore, is to keep the pit as empty as possible by positioning the falling blocks as closely together (there are a couple different shapes of blocks). If there is enough room for the block to land, points will be added to your score.

The higher the block lands and the higher the difficulty level, the more points you will receive, but remember, you don't want to have the blocks build up to high or else the entrance for the blocks will be blocked and the game will end.

Other features of Addictus include PAUSE (you should use this a lot to plan out your strategy ie: how you want to rotate the block and where will it fit best), pressing ESCAPE will restart a futile game (another much used option) and pressing CLEAR at the title screen will clear the high scores permanently.

Also, there is use of windows in two parts of Addictus (when you have lost and when you are going to clear the high scores) which is very impressive.

In summary, **Reedy Software has done it** again folks. The game operates very smoothly and does become addicting. Everything about the way the game setup and operation is very professionally put together and it is a very good addition to anyone's software collection.

My hats of to Jack Reedy for another great addition, Addictus is a real eye-opener and should appeal to all ages, not just adults.

RATING - A+
HIGHLY RECOMMENDED



AUG REVIEWS

...(Continued from page 5)

MOAUG

The Metro Orlando AUG sponsors this monthly publication. The editor is a longtime ADAM enthusiast who has cheerfully helped many ADAM support firms. A talented artist...upbeat writer...and Mensa member, Pat adds a unique appeal to the group's newsletter.

FREQUENCY: Monthly
ANNUAL RATE: \$12 USA
EDITOR: Pat Herrington
PUBLISHER: MOAUG
OF PAGES: 12
STARTED: January 1985
OF ISSUES: 36
ADDRESS: MOAUG - 1003 Oak Lane -
Apopka, FL 32703

PSAN

The Puget Sound ADAM NewsNet is another chiefly local paper that accepts national memberships. Each issue contains a variety of original information along with excerpts from other periodicals. The local group also sponsors mountain retreats (with ADAM along) a couple times a year.

FREQUENCY: Monthly
ANNUAL RATE: \$5 USA
EDITORS: Bob & Valorie Zimmerman
PUBLISHERS: PSAN
OF PAGES: 3-6
STARTED: January 1985
OF ISSUES: 48
ADDRESS: Puget Sound ADAM NewsNet - 22607 SE 322nd
Kent, WA 98052

SAINT LOUIS AUG

This is one of the newer publications. The group's founder is Barry Wilson who started distributing PD software a couple years ago. Their premier issue was May of this year. They have grown rapidly over the past few months with a new professional newsletter format, monthly group meetings, a BBS, and a new wholesale mail order business is on the horizon. The newsletter is segregated into two sections: original articles and reprints from other periodicals. This is a group with a lot of promise featuring five well known and very active ADAM owners: Don Buelmann, Father Al Fitzgerald, Jim Guenzel, Rev. Michael Keith and Barry Wilson.

FREQUENCY: Monthly
ANNUAL RATE: \$23 USA
EDITORS: Barry Wilson & Mike Keith
PUBLISHER: SLAUG
OF PAGES: 20-26
STARTED: May 1988
OF ISSUES: 9
ADDRESS: St. Louis AUG - 12967 Weatherfield Drive -
St. Louis, MO 63146

CLIP ART
from: PaintMATES83

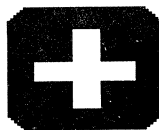
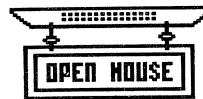
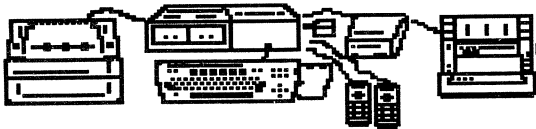
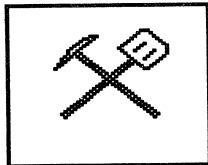
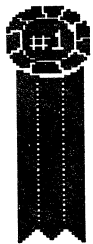
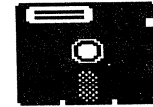

PRODUCT LIST

EFFECTIVE 3/15/89 & SUBJECT TO CHANGE WITHOUT NOTICE

HARDWARE/ACCESSORIES

- **SINGLE SIDED ADAM DISK DRIVE \$CALL**
160K Coleco disk drive for the ADAM
- **SINGLE SIDED DISK DRIVE EPROM CHIP**
..... **\$17.95**
Greatly reduces disk formatting time. User must install.
- **DBL SIDED DISK DRIVE EPROM CHIP \$19.95**
For use with older double sided drive conversions, reduces read/ write time of most operations - user must install.
- **DBL SIDED ADAM DISK DRIVE..... \$259.95**
Modified Coleco disk drive provides 320K of storage using 5 1/4 disks. Comes with all software.
- **3 1/2 In 720K ADAM DISK DRIVE....\$289.95**
Modified Coleoc drive provides use of new 3 1/2 inch diskettes and giv 720K of storage. Comes with software and utilities.
- **UPGRADE SINGLE SIDED DRIVE TO:**
- **320K 5 1/4 \$125.00**
- **720K 3 1/2 \$155.00**
Send in your Coleco single sided drive to be upgraded to either a 5 1/4 inch double sided 320K or 3 1/2 inch 720K drive.
Send payment to NIAD, but send drive to:
NIAD DRIVE UPGRADE
1010 Westminster
Garland, TX 75040
- **DIGITAL DATA DRIVE \$29.95**
Replacement or additional second data drive for the ADAM console.
- **64K MEMORY EXPANDER**
- **(WITHOUT 2 MEMORY CHIPS)\$27.95**
- **(WITH MEMORY CHIPS)\$69.95**
Provides an additional 64K of memory for specified programs. Card that is easily installed in the memory console. If purchased without memory chips, all other components are supplied, inc sockets for 2 4464 memory chips.
- **PARALLEL PRINTER INTERFACE.. \$44.95**
Interface card that provides ability to print text/ graphics on any standard dot matrrix printer. NEW version has user DIP switches for addressing 8 ADAM ports. Installs in the memory console - requires parallel printer cable below.
- **PARALLEL or SERIAL PRINTER CABLE \$15.95**
Attaches to printer interface card and any printer.
- **SHIELDED PARALLEL CABLE \$24.95**
Same as above, but with shielding to prevent interference.
- **MEGACOPY TAPE MAKER.....\$59.95**
Hardware device with software to create ADAM compatible cassette tapes using the ADAM itself.

- **MONITOR CABLE\$9.95**
Allows attaching of a composite monitor to the ADAM memory console, providing both audio and video.
NOTE: Not available for the ADAM Expansion unit that attaches to the Colecovision game unit.
- **DISK DRIVE POWER SUPPLY..... \$19.95**
- **ADAM PRINTER POWER SUPPLY. \$24.95**
"Bare" Power supply from the ADAM printer.
- **ADAM POWER SUPPLY W/COVER \$49.95**
Standalone power supply that can be used in place of ADAM printer power supply. Metal cover with power on light included.
- **COMPUSERVE STARTER KIT..... \$29.95**
Includes ID, password, CIS information guide and reference book and \$25 credit towards usage of online time.
- **MAG'VX 8502 COLOR MONITOR... \$199.95**
Composite color monitor provides superior picture compared to television. Use ADAM monitor cable above to obtain both audio/ video.
- **MAG'VX 8762 COLOR MONITOR... \$299.95**
Same as above but provides higher resolution and RGB input for compatibility with IBM PC and other RGB color computers. 80 column display in RGB mode.
- **SURGE PROTECTORS**
- ⇒ **3 OUTLET\$ 12.95**
- ⇒ **6 OUTLET STRIP\$ 24.95**
- **POWER CENTER /5 OUTLET \$99.95**
Monitor stand with 5 integrated outlets and switches, including master switch. Full surge and noise protection. Anti static pad included.
- **NEW ADAM KEYBOARD..... \$19.95**
- **NEW TAN HAND CONTROLLERS.. \$9.95**
- **ADAMNET CABLES \$2.95**
Flat, 7 foot cables for either keyboard or disk drive.
- **NIAD PRODUCT REVIEW BOOK \$19.95**
Contains detail reviews of over 100 ADAM products. Save money by knowing products before you buy.
- **SMARTBASIC PD DESCRI'P'S \$5.00**
Manual contains descriptions of all the programs in over 30 volumes of SMARTBASIC PUBLIC DOMAIN. Use to determine which volumes of PD to buy.

SERVICES

- **SUPERGAME CONVERSION TO DISK\$4.00**
We will convert your supergames to disk version for faster game play. Send in the title card from your supergame ddp case and \$4 for each game.
- **SMARTFILER FIX..... \$4.00**
Send in your SMARTFILER ddp/disk and we will upgrade it

PRINTERS

- **PANASONIC 1080i-2** **\$199.95**
 (with ADAM printer interface & cable) **\$239.95**
 9 by 9 dot matrix printer with 1K buffer and parallel interface.
 Draft speed 144 CPS; Near Letter Quality speed 28 CPS
 Two year limited warranty
- **PANASONIC 1091i-2** **\$229.95**
 (with ADAM printer interface & cable) **\$269.95**
 Same as 1080i-2 above but draft speed is 192 CPS and NLQ
 speed is 32 CPS.
- **OKIMATE 20 COLOR PRINTER**..... **\$199.95**
 24 pin thermal printer capable of black/ white and full color
 printing. Parallel "Plug 'N Print" module supplied.
 Includes 8K buffer, special thermal paper required.
 Draft speed 80 CPS, 40 CPS NLQ mode. Special software
 required for ADAM to print in color.
- **RIBBONS**
 - Genuine Panasonic brand for 1080/1091\$9.95
 - Generic brand for Panasonic\$5.95
 - Okimate 20 Color ribbon\$5.95
 - Okimate 20 Black ribbon\$4.95

TRAINING MANUALS/ BOOKS

- **Basic Basic Programs for ADAM** ... **\$8.25**
- **Discovering Science on the ADAM w/ 25 Programs**..... **\$9.95**
- **The Coleco ADAM Entertainer** **\$12.95**
- **Hacker's Guide to ADAM Vol 1**..... **\$11.95**
- **Hacker's Guide to ADAM Vol 2**..... **\$11.95**
- * Disk/ DDP of all the programs in both Volume 1 and 2 of
 Hacker's Guide **\$5.00**
- **Using & Programming ADAM** **\$7.95**
- **ADAM Manuals**..... **\$15.00**
 (Ones originally supplied with the ADAM computer)

SEGA GAME SYSTEM

- **MASTER GAME SYSTEM** **\$109.95**
 - ⇒ 2 HAND CONTROLLERS
 - ⇒ LIGHT PHASER GUN
 - ⇒ 2 GAMES - HANG ON/ SAFARI HUNT
- **BASE GAME SYSTEM**..... **\$79.95**
 - ⇒ 2 HAND CONTROLLERS
 - ⇒ 1 GAME - HANG ON
- **3D GLASSES**..... **\$39.95**
 TRUE 3D PROVIDED VIA HIGH TECHNOLOGY LCD
 SHUTTER SYSTEM
- **SEGA CARD SOFTWARE**..... **\$24.95**
 - ⇒ MY HERO
 - ⇒ TEDDY BOY
 - ⇒ SUPER TENNIS
 - ⇒ SPY VS SPY
- **SEGA MEGA CARTRIDGES**..... **\$29.95**
 - ⇒ FOOTBALL
 - ⇒ VOLLEYBALL
 - ⇒ FANTASY ZONE
 - ⇒ WORLD GRAN PRIX
 - ⇒ SOCCER
 - ⇒ GHOSTBUSTERS
 - ⇒ GOLF
 - ⇒ GANSTER TOWN
 - ⇒ KUNG FU KID
 - ⇒ SHOOTING GALLERY
- **3D GAMES** **\$39.95**
 - ⇒ MAZE HUNTER 3D
 - ⇒ ZAXXON 3D
 - ⇒ BLADE EAGLE 3D
- **NEW GAMES**
 - ⇒ MIRACLE WARRIORS \$46.95
 - ⇒ SHINOBI \$41.95
 - ⇒ PHANTASY STAR \$59.95
 - ⇒ RAMBO III \$41.95
 - ⇒ FARLOUR GAMES \$29.95
 - ⇒ PENQUIN LAND \$41.95

OTHER SOFTWARE

Specify DDP or DISK

VIDEOTUNES	\$ 26.95	
FANTASY GAMER	\$ 22.95	
BASIC BONANZA	\$ 22.95	
SOFTPACK I	\$ 18.95	
LVAC ARCHIVE I	\$ 9.95	
REEDY SOFTWARE LIB	\$ 15.95	
BUSINESS PACK	\$ 18.95	
QUICKCOPY	\$ 15.95	
ELECTRIC GAME PACK (DISK)	\$ 17.95	
Specify I or II (DDP)	\$ 19.95	
NUMBER BUMPER	\$ 15.95	
REEDY (DISK)	\$ 15.95	
ENTERTAINMENT PACK (DDP)	\$ 17.95	
JEOPARDY QUESTION PACK	\$ 14.95	SPECIAL
FAMILY FEUD QUESTION PACK	\$ 14.95	SPECIAL
TRIVIA PACK I	\$ 12.95	
KIDS TRIVIA	\$ 12.95	
PRO FOOTBALL	\$ 18.95	
BACKUP 3.0 (COPY ONLY)	\$ 16.95	DISK ONLY
SMARTGAMES PACK	\$ 9.95	
ROYAL AMBS. EDUC PCK	\$ 9.95	
(Christian pgms)		
CPM NEVADA BASIC	\$ 39.95	
SP-1 CUSTOM SOFTWARE for	\$ 7.00	
Smartwriter/Files (Specify printer)		
ADDRESS BOOK/CALENDAR	\$ 9.95	
JEOPARDY QUESTION MAKER		
FAMILY FEUD QUEST MAKER		
Each of Quest Makers	\$ 24.95	
EASY COME, EASY GO	\$ 19.95	
WIZARD'S PINBALL ARCADE	\$ 19.95	
ADAMTALK	\$ 19.95	
Interpreter for EVE Speech Synthesizer		
SOLAR SYSTEM Quiz (DDP)	\$ 9.95	
AMERICA AT WAR Quiz (DDP)	\$ 9.95	
WORLD GEO. Quiz (DDP)	\$ 9.95	
HOME FILE MANAGER (DDP)	\$ 9.95	
PERSONAL CHECKBOOK (DDP)	\$ 9.95	
HOME BUDGET (DDP)	\$ 9.95	
BASIC SYSTEM MGR/FASTRUN	\$ 18.95	
LAB MOUSE	\$ 12.95	
STATES and CAPITOLS (DDP)	\$ 9.95	
WORLD CAPITOLS (DDP)	\$ 9.95	
GREAT INVENTIONS (DDP)	\$ 9.95	
BASICAIDE	\$ 9.95	
SMART TYPE 2.0	\$ 17.95	
PROOF READER (DDP)	\$ 34.95	
NIAD GOLD SERIES		
GAMES 1	\$ 9.95	
TEXT ADVENTURE	\$ 9.95	
HOME/BUSINESS	\$ 9.95	
SCIENCE/EDUCATION	\$ 9.95	
STAGE FRIGHT	\$ 19.95	
ADAMCALC Dot Matrix PATCH	\$ 9.95	
ADAMLINK Dot Matrix PATCH	\$ 9.95	
BEYOND TREK (64K Req)	\$ 16.95	
AUTO WRITER	\$ 14.95	
FILE MANAGER	\$ 17.95	
CHESS CHAMPION (64k req)	\$ 15.95	
ADAMLINK III	\$ 18.95	
SPEEDYWRITE V2.0	\$ 39.95	
PRO GOLF CHAMP	\$ 14.95	
MR. T SEARCH	\$ 12.95	
MR. T SEARCH GAME PAK 1	\$ 9.95	
SMARTDSK I (For Smartwriter)	\$ 18.95	
SMARTDSK II	\$ 16.95	
(For Basic 1.0/2.0, Adamcalc, Flash Maker)		
SMARTDSK III	\$ 24.95	
(For Basic 1.0/2.0 With Cmpl. Utility)		
TRIVIA SEARCH	\$ 7.95	
(Requires Mr. T Search)		
PHRASE CRAZE	\$ 19.95	
PHRASE PAK 1 or 2	\$ 9.95	NEW
PHRASE PAK CONSTRUCTION	\$ 9.95	NEW

OTHER SOFTWARE

CONTINUED

NEWSMAKER	\$ 26.95	
PR BOOT	\$ 17.95	
SPELLING AID	\$ 26.95	
MISSPELLER	\$ 18.95	
DBL DISK FORMATTER	\$ 8.95	
AUTO BACKUP	\$ 17.95	
MIND OVER ADAM	\$ 11.95	
SMART TERM 1.0	\$ 15.95	
LAS VEGAS CRAPS	\$ 16.95	NEW DISK ONLY
COPYCART+ D 2.0	\$ 19.95	NEW
LINK BUILDER	\$ 24.95	NEW
AFL FOOTBALL	\$ 14.95	NEW
SUB RAIDERS	\$ 24.95	NEW
PRINT WORKS	\$ 27.95	NEW
BASEBALL STATISTICIAN	\$ 12.95	NEW
GHOST ZAPPER	\$ 11.95	NEW
TEMPLE of SNOW DRAGON	\$ 21.95	NEW
RAMBOOT	\$ 19.95	NEW
SPEEDYWRITE SPELL	\$ 24.95	NEW
OPENFILER V3.0	\$ 19.95	NEW
ADAMBOMB	\$ 19.95	NEW
FORMATTER 2	\$ 12.95	NEW
EASY as A,B,C & 1,2,3	\$ 11.95	NEW
SMARTAX	\$ 17.95	NEW
ADDICTUS	\$ 15.95	NEW
INVOICER	\$ 14.95	NEW

COLECO SOFTWARE

(DDP unless noted)

SMART LOGO	7600	\$ 29.95	SPECIAL
SMART FILER	7813	\$ 15.95	
RECIPE FILER	7814	\$ 10.95	SPECIAL
SMART LTRS/FORMS	7805	\$ 15.95	
FLASHCARD MAKER	7662	\$ 15.95	
FLASHFACTS (TRIVIA 2902, HISTORY 2901, VOCAB 2900)		\$ 11.95	EACH
CP/M 2.2	7832	\$ 29.95	
ADAMCALC	7831	\$ 24.95	
R. SCARRY WORDBOOK	7658	\$ 20.95	
DONKEY KONG		\$ 19.95	
SUPER ZAXXON	2632	\$ 9.95	SPECIAL
SUPER ACTION CONTROLLER/With Baseball		\$ 49.95	SPECIAL

(Specify DDP or DISK)

ACTIVISION SOFTWARE

ALCAZAR	\$ 14.95	REDUCED*
ROCK n' BOLT	\$ 19.95	REDUCED*
BOULDER DASH	\$ 19.95	REDUCED*
RIVER RAID	\$ 17.95	REDUCED*
KEYSTONE KAPERS	\$ 17.95	REDUCED*
PITFALL II	\$ 17.95	REDUCED*
DECATHLON	\$ 17.95	REDUCED*

IMAGIC SOFTWARE

TENNIS	\$ 19.95	REDUCED*
MOONSWEeper	\$ 15.95	REDUCED*

INTERPHASE SOFTWARE

SEWER SAM	\$ 17.95	REDUCED*
AQUA ATTACK	\$ 17.95	REDUCED*
BLOCKADE RUNNER	\$ 15.95	REDUCED*
SQUISH'M SAM	\$ 15.95	REDUCED*

NEW PUBLIC DOMAIN (\$6.00 DDP, \$4.00 DISK)

CABBAGE PATCH ADV. IN PARK 128K version		
FALL GUY and VIDEO HUSTLER		
YOKES ON YOU and MATH WIZ		

**NIAD USER GROUP PRODUCTS
 PUBLIC DOMAIN**

PLEASE Specify VOLUME # and DISK/DDP
 NOTE: COST per VOLUME:
 \$ 4.00 DISK - \$ 6.00 DDP

- SMARTBASIC # 1 - 32 (32 Different)
 # BNDV1 - 32 (Vol numbers)
- SMARTLOGO # 1 - 4 (4 Volumes)
 # LNDV1 - 4
- ADAMCALC # 1 - 2 (2 Volumes)
 # ANDV1 - 2
- BASIC UTILITIES # 1 - 2 (2 Volumes)
 # UNDV1 - 2
 (Vol 1 includes backup utility)
- CPM2.2 # 1 - 54 (54 Volumes)
 # CNDV1 - 54
- JEOPARDY
- PINBALL/HARDHAT MACK
 New BUG FREE vers with 2 DEMO games
 Add \$ 2.00 for 40 page manual
- PINBALL GAMES (Volumes 1 and 2)
 Requires Pinball/Hardhat Mack
- SUPER SUBROC
- TROLLS TALE
- ADAM DIAGNOSTIC Requires 64K expander
- ADAMLINK II TELECOMMUNICATIONS
- SMARTBASIC REPLACEMENT DDP
- SMARTBASIC V2.0 with Doc. file
- NIAD BACK ISSUE INDEX - Smartfiler file
- EOS DISK MANAGER - (Replacement on Disk or DDP)
- CUSTOM PRINTER SOFTWARE \$ 7.00
- VIDEOTUNE SONGS Volumes 1 and 2
- 1 MINUTE FORMATTER (Disk)
- UKAS MINI REVIEWS
- A-CHESS
- ANIMATOR
- SPEEDCHECK - DISK/DDP

SUPPLIES

RIBBONS

- ADAM REPLACEMENT \$ 4.95 EACH
- PANASONIC 1080/1090I \$ 9.95 EACH
- OKIMATE 20 RIBBONS Black \$ 4.95 EACH
- Color \$ 5.95 EACH

COVERS

- 3 PIECE for COMPLETE ADAM \$ 18.95
- DISK DRIVE ONLY \$ 8.95
- 3 PIECE for EXPANSION ADAM \$ 23.95

PRINTER WHEELS

- \$ 5.55
- SPECIFY FONT STYLE for the ADAM printer
 Gothic 12, Script 12, Elite 12, Emphasis,
 Courier 72, Pica

- TAPE DRIVE HEAD CLEANING KIT \$.50
- DISK DRIVE HEAD CLEANING KIT \$ 7.95
 Contains 2 cleaning diskettes/fluid

DISK/DIGITAL DATA PACKS

- COLECO/LORAN DDP \$ 4.75 EACH
- 10 for \$ 39.95
- NIAD/LORAN DDP \$ 4.25 EACH
- 10 for \$ 34.95
- NIAD (Non LORAN) DDP 10 for \$ 19.00
- BOX of 10 LORAN DS/DD Diskettes \$ 9.95
- GENERIC 50 Diskettes \$ 19.95 SPECIAL
- RIGHT DIR. DDP for Supergame copy \$ 2.50

PINFEED PAPER/LABELS

- 9 1/2 x 11 20# MICROPERF PAPER \$ 9.95 /500
- \$ 16.95 /1000
- 9 1/2 x 11 OKI 20 THERMAL PAPER \$ 9.95 /250
- 3 1/2 x 15/16 PIN FEED ADDR LABEL \$ 6.95 /1000

CARTRIDGE SOFTWARE

Colecovsion/Adam

- SUESS FIXUP PUZZLE 2699 \$ 18.95
- T.TURTLE LOGO/GRPHICS 2698 \$ 18.95
- BEAMRIDER \$ 22.95
- HERO \$ 12.95
- CABBAGE PATCH PICTURE SHOW \$ 18.95
- HEIST \$ 18.95
- NOVA BLAST \$ 18.95
- GORF \$ 18.95
- CENTIPEDE \$ 12.95
- DEFENDER \$ 12.95
- TIME PILOT \$ 9.95 NEW

**CP/M 2.2 COMML SOFTWARE
 INFOCOM PRODUCTS**

*Requires ADAM CP/M software
 DISK only*

- ZORK I \$ 19.95 SPECIAL
- ZORK II, III \$ 24.95
- STARCROSS \$ 19.95
- DEADLINE \$ 19.95
- HITCHHIKERS GUIDE \$ 19.95 SPECIAL

GRAPHIC PRODUCTS

DOT MATRIX PRINTER REQUIRED

- GRAPHXPAINTEER \$ 19.95
- GRAPHIXPIX \$ 14.95
- POWERPAINT \$ 34.95
- CLIPPER \$ 14.95
- CLIP ART Vol 1 & 2 (Each) \$ 12.95
- PAINTAIDE \$ 18.95
- POWERPRINTS I \$ 12.95
- PRINTWORKS \$ 27.95 NEW
- BORDER PLUS (For Printworks) \$ 15.95 NEW

BASIC SPRITE GRAPHICS PGM

- SPRITEMASTER \$ 18.95
- SPRITEPOWER \$ 16.95

ADAM PRINTER USED

- SIGNSHOP \$ 22.95
- SNAPSHOTS (Vol 1) \$ 10.95
- PD SIGNS (Vol 1 & 2) (Disk) \$ 4.00
- (DDP) \$ 6.00

MONITOR/TV ONLY

- PAINTMASTER \$ 22.95

MISC PD GRAPHICS

NOTE: COST per VOLUME: \$ 4.00 DISK - \$ 6.00 DDP
 Can be viewed only or printed on Dot Matrix

- RLE PICS (Vol 1, 2, 3)
- REEDY ART GALLERY (Vol 1, 2)
- PAINTMATES (Vol 1 - 11)
- PAINTFORMS (Vol 1 - 3)
- N & B PIX (Vol 1 - 18)

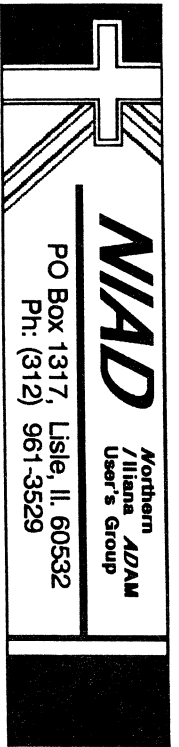

MULTI-FUNCTION USER GROUP
MONTHLY NEWSLETTER - PUBLIC DOMAIN LIBRARY
DISCOUNT BUYING SERVICE FOR HDW & SFTW

" For God so loved the world that he gave his one and only SON, that whoever believes in him shall not perish but have eternal life. For God did not send his SON to condemn the world, but to save the world through him. . . . John 3:16

NIAD NEWSLETTER For →

Member # ----->0290sp14912075
Steve Pitman
3705 Church St
Cincinnati, OH
45244 *



BULK RATE
U.S. Postage
PAID
Lisle, IL 60532
Permit No. 468

POSTMASTER : DATED MATERIAL - PLEASE DELIVER